

Article number: 203502803994ST

Description: E+G Levelling sets GN 350.2-80-39-94-ST

Measures

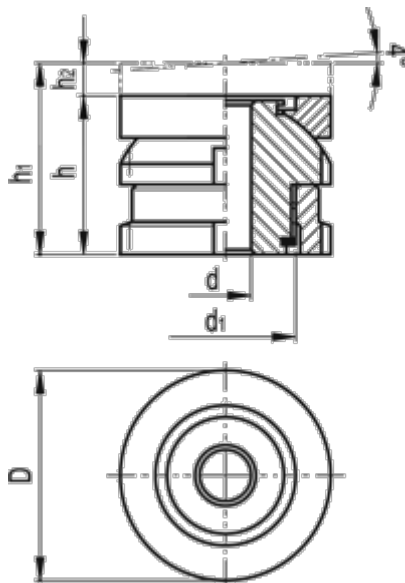

C-spanner DIN 1810 = A80-90

d = 39

D = 80

d1 = M60x2

For screw = M36

h = 94

h1 = 144

h2 = 50

Max static load (kN) = 323

Static preload (kN) = 38.2

Weight (g) = 2560